

Mezzanine Card Series

Introduction

Thank you for purchasing ASRock Rack mezzanine card, a reliable mezzanine card produced under ASRock Rack's consistently stringent quality control. It delivers excellent performance with robust design conforming to ASRock Rack's commitment to quality and endurance.

Model	Dimension	Interface	LAN Controller	LAN Connector
M350	2.7" x 4.3" (6.8 cm x 10.9 cm)	Gigabit LAN 10/100/1000 Mb/s	1 x Intel® i350	2 x RJ45
M540	2.7" x 4.3" (6.8 cm x 10.9 cm)	10G/1G/100M/s	1 x Intel® X540	2 x RJ45 (10G Base-T)
M599	2.7" x 4.3" (6.8 cm x 10.9 cm)	10G/s	1 x Intel® 82599ES	2 x SFP+ (Fiber)
M350R	2.7" x 4.3" (6.8 cm x 10.9 cm)	Gigabit LAN 10/100/1000 Mb/s	1 x Intel® i350	2 x RJ45
M540R	2.7" x 4.3" (6.8 cm x 10.9 cm)	10G/1G/100M/s	1 x Intel® X540	2 x RJ45 (10G Base-T)
M599R	2.7" x 4.3" (6.8 cm x 10.9 cm)	10G/s	1 x Intel® 82599ES	2 x SFP+ (Fiber)
M710	2.7" x 4.3" (6.8 cm x 10.9 cm)	10/40Gb/s	1 x Intel® XL710-AM2	2 x QSFP+ 40Gb/s
M710S	2.7" x 4.3" (6.8 cm x 10.9 cm)	10/40Gb/s	1 x Intel® XL710-AM1	1 x QSFP+ 40Gb/s
MCX3	2.7" x 4.3" (6.8 cm x 10.9 cm)	10/40Gb/s	1 x Mellanox ConnectX®-3 Pro EN	2 x QSFP+ 40Gb/s

M350

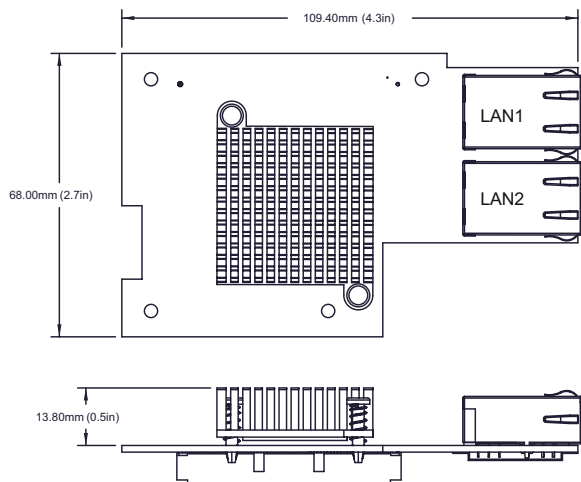

Package Contents

- 1 x Mezzanine Card
- 4 x Screws
- 4 x Standoffs
- 4 x Nuts
- 1 x Support CD
- 1 x Quick Installation Guide

Layout

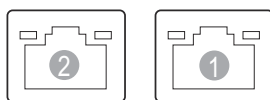

- 1 LAN RJ-45 Port (LAN1)
- 2 LAN RJ-45 Port (LAN2)

LAN Port LED Indications

Activity / Link LED

Status	Description
Off	No Link
Blinking	Data Activity
On	Link

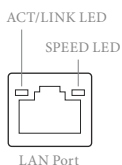

Speed LED

Status	Description
Off	10Mbps connection
Orange	100Mbps connection
Green	1Gbps connection

Onboard Header

Front LAN LED Connector
(LAN_LED_1)

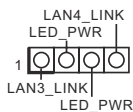

This 4-pin connector is used for the front LAN status indicator.



Onboard headers and connectors are NOT jumpers. Do NOT place jumper caps over these headers and connectors. Placing jumper caps over the headers and connectors will cause permanent damage to the motherboard.

M540

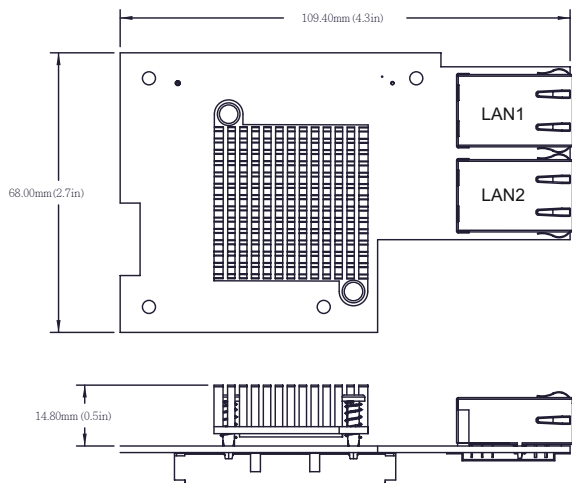

Package Contents

- 1 x Mezzanine Card
- 4 x Screws
- 4 x Standoffs
- 4 x Nuts
- 1 x Support CD
- 1 x Quick Installation Guide

Layout

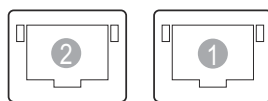

- 1 LAN RJ-45 Port (10G Base-T)(LAN1)
- 2 LAN RJ-45 Port (10G Base-T)(LAN2)

LAN Port LED Indications

Activity / Link LED

Status	Description
Off	No Link
Blinking	Data Activity
On	Link

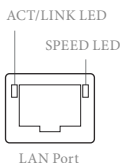

Speed LED

Status	Description
Off	10Mbps connection
Orange	100Mbps connection
Green	1Gbps connection

Onboard Header

Front LAN LED Connector
(LAN_LED_1)

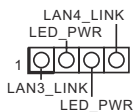

This 4-pin connector is used for the front LAN status indicator.



Onboard headers and connectors are NOT jumpers. Do NOT place jumper caps over these headers and connectors. Placing jumper caps over the headers and connectors will cause permanent damage to the motherboard.

M599

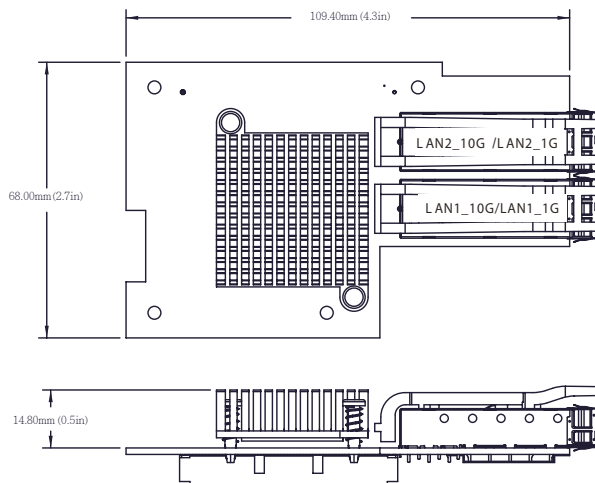

Package Contents

- 1 x Mezzanine Card
- 4 x Screws
- 4 x Standoffs
- 4 x Nuts
- 1 x Support CD
- 1 x Quick Installation Guide

Layout

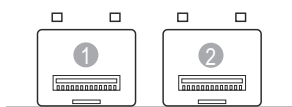

- 1 SFP+ Port (Fiber) (LAN1)
- 2 SFP+ Port (Fiber) (LAN2)

LAN Port LED Indications

Activity / Link LED

Status	Description
Off	No Link
Blinking	Data Activity
On	Link

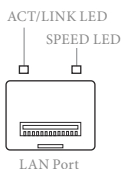

Speed LED

Status	Description
Off	10Mbps connection
Orange	100Mbps connection
Green	1Gbps connection

Onboard Header

Front LAN LED Connector
(LAN_LED_1)

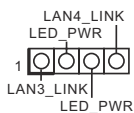

This 4-pin connector is used for the front LAN status indicator.



Onboard headers and connectors are NOT jumpers. Do NOT place jumper caps over these headers and connectors. Placing jumper caps over the headers and connectors will cause permanent damage to the motherboard.

M350R

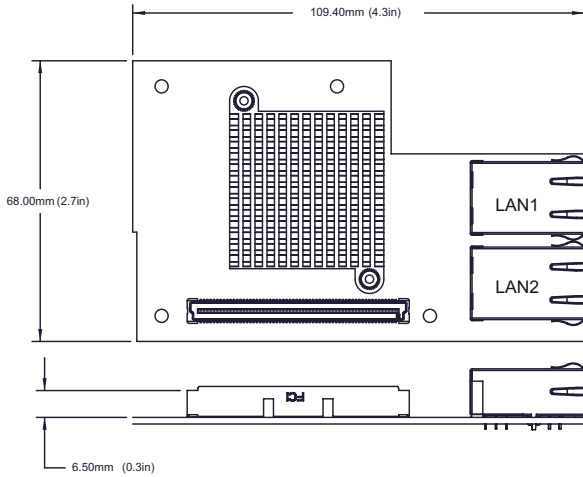

Package Contents

- 1 x Mezzanine Card
- 4 x Screws
- 4 x Standoffs
- 4 x Nuts
- 1 x Support CD
- 1 x Quick Installation Guide

Layout

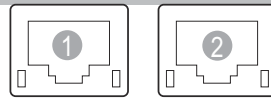

- 1 LAN RJ-45 Port (LAN1)
- 2 LAN RJ-45 Port (LAN2)

LAN Port LED Indications

Activity / Link LED

Status	Description
Off	No Link
Blinking	Data Activity
On	Link

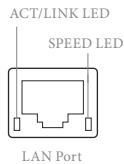

Speed LED

Status	Description
Off	10Mbps connection
Orange	100Mbps connection
Green	1Gbps connection

Onboard Header

Front LAN LED Connector
(LAN_LED_1)

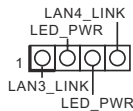

This 4-pin connector is used for the front LAN status indicator.



Onboard headers and connectors are NOT jumpers. Do NOT place jumper caps over these headers and connectors. Placing jumper caps over the headers and connectors will cause permanent damage to the motherboard.

M540R

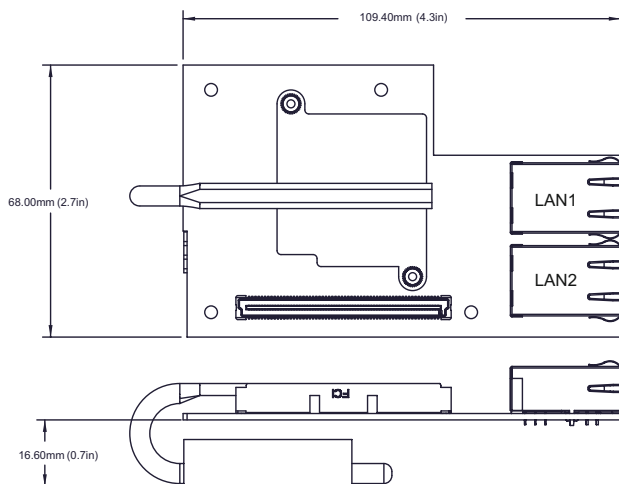

Package Contents

- 1 x Mezzanine Card
- 4 x Screws
- 4 x Standoffs
- 4 x Nuts
- 1 x Support CD
- 1 x Quick Installation Guide

Layout

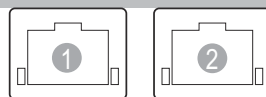

- 1 LAN RJ-45 Port (10G Base-T)(LAN1)
- 2 LAN RJ-45 Port (10G Base-T)(LAN2)

LAN Port LED Indications

Activity / Link LED

Status	Description
Off	No Link
Blinking	Data Activity
On	Link

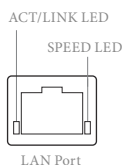

Speed LED

Status	Description
Off	10/100Mbps connection
Orange	1Gbps connection
Green	10Gbps connection

Onboard Header

Front LAN LED Connector
(LAN_LED_1)

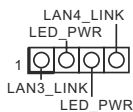

This 4-pin connector is used for the front LAN status indicator.



Onboard headers and connectors are NOT jumpers. Do NOT place jumper caps over these headers and connectors. Placing jumper caps over the headers and connectors will cause permanent damage to the motherboard.

M599R

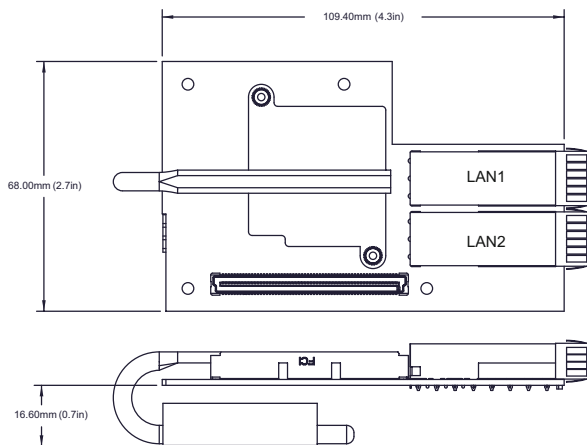

Package Contents

- 1 x Mezzanine Card
- 4 x Screws
- 4 x Standoffs
- 4 x Nuts
- 1 x Support CD
- 1 x Quick Installation Guide

Layout

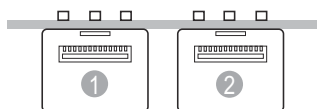

- 1 SFP+ Port (Fiber) (LAN1)
- 2 SFP+ Port (Fiber) (LAN2)

LAN Port LED Indications

Activity / Link LED

Status	Description
Off	No Link
Blinking	Data Activity
On	Link

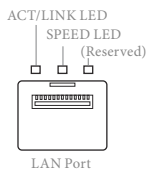

Speed LED

Status	Description
Off	10/100Mbps connection
Off	1Gbps connection
Green	10Gbps connection

Onboard Header

Front LAN LED Connector
(LAN_LED_1)

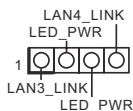

This 4-pin connector is used for the front LAN status indicator.



Onboard headers and connectors are NOT jumpers. Do NOT place jumper caps over these headers and connectors. Placing jumper caps over the headers and connectors will cause permanent damage to the motherboard.

M710

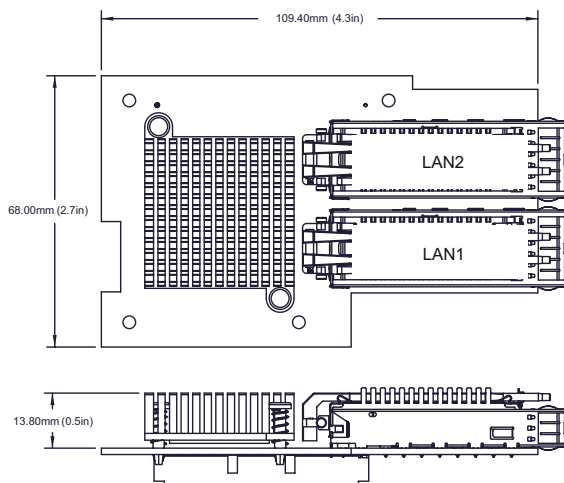

Package Contents

- 1 x Mezzanine Card
- 4 x Screws
- 4 x Standoffs
- 4 x Nuts
- 1 x Support CD
- 1 x Quick Installation Guide

Layout

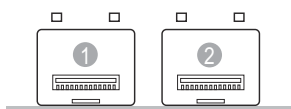

- 1 QSFP+ 40Gb/s (LAN1)
- 2 QSFP+ 40Gb/s (LAN2)

LAN Port LED Indications

Activity / Link LED

Status	Description
Off	No Link
Blinking	Data Activity
On	Link

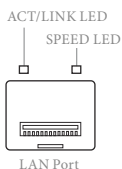

Speed LED

Status	Description
Off	10/100Mbps connection
Off	1Gbps connection
Green	10/40Gbps connection

Onboard Header

Front LAN LED Connector
(XL_LAN_LED)

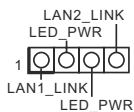

This 4-pin connector is used for the front LAN status indicator.



Onboard headers and connectors are NOT jumpers. Do NOT place jumper caps over these headers and connectors. Placing jumper caps over the headers and connectors will cause permanent damage to the motherboard.

M710S

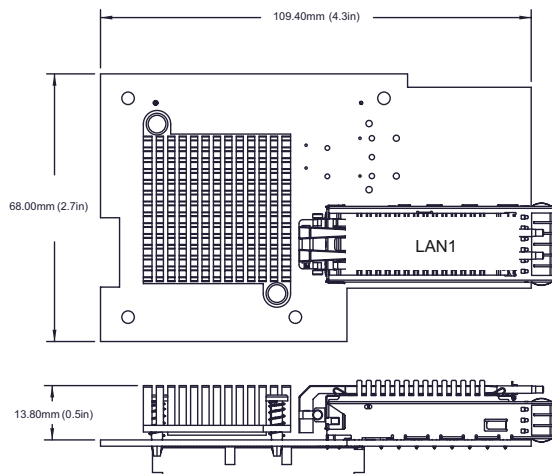

Package Contents

- 1 x Mezzanine Card
- 4 x Screws
- 4 x Standoffs
- 4 x Nuts
- 1 x Support CD
- 1 x Quick Installation Guide

Layout

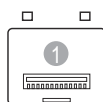

1 QSFPP+ 40Gb/s (LAN1)

LAN Port LED Indications

Activity / Link LED

Status	Description
Off	No Link
Blinking	Data Activity
On	Link

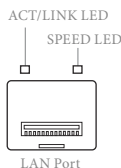

Speed LED

Status	Description
Off	10/100Mbps connection
Off	1Gbps connection
Green	10/40Gbps connection

Onboard Header

Front LAN LED Connector
(XL_LAN_LED)

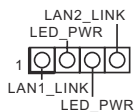

This 4-pin connector is used for the front LAN status indicator.



Onboard headers and connectors are NOT jumpers. Do NOT place jumper caps over these headers and connectors. Placing jumper caps over the headers and connectors will cause permanent damage to the motherboard.

MCX3

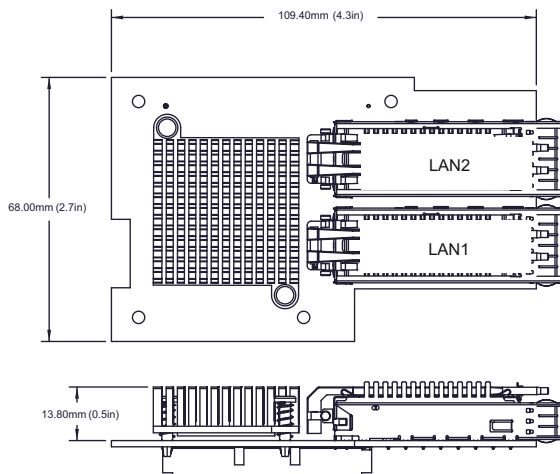

Package Contents

- 1 x Mezzanine Card
- 4 x Screws
- 4 x Standoffs
- 4 x Nuts
- 1 x Support CD
- 1 x Quick Installation Guide

Layout

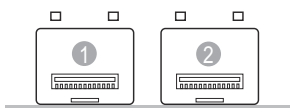

- 1 QSFP+ 40Gb/s (LAN1)
- 2 QSFP+ 40Gb/s (LAN2)

LAN Port LED Indications

Activity / Link LED

Status	Description
Off	No Link
Blinking	Data Activity

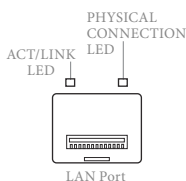

Physical Connection LED

Status	Description
On	Connected
Off	Disconnected

Onboard Header

Front LAN LED Connector
(LAN_LED1)

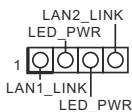

This 4-pin connector is used for the front LAN status indicator.



Onboard headers and connectors are NOT jumpers. Do NOT place jumper caps over these headers and connectors. Placing jumper caps over the headers and connectors will cause permanent damage to the motherboard.

Mezzanine Card Installation

Before installing a mezzanine card to a motherboard, remove the motherboard from the chassis. To do so, be sure to power down the system and remove all connected cables first. For more details, refer to the user manual that comes with your system.

Note: The illustrations are for reference only and may slightly different from the real products due to different models.

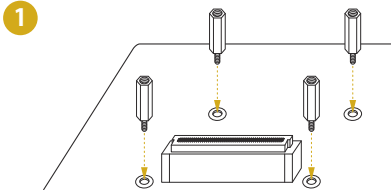

1. Install the four standoffs into the motherboard around the mezzanine card slot.

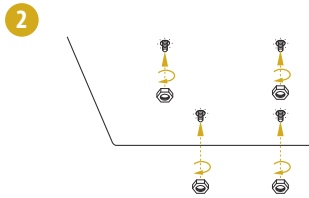

2. Install the four lock nuts on the bolts under the motherboard. Hand-tighten the nuts.

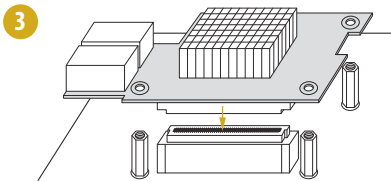

3. Gently insert the mezzanine card into the mezzanine card slot on the motherboard.

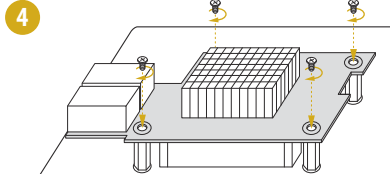

4. Use screws to secure the mezzanine card to the motherboard standoffs.

When the mezzanine card is well installed, horizontally slide the motherboard back to the chassis so the I/O connectors fit through the I/O openings at the rear of the chassis. Well install the motherboard to the chassis with screws. For more details, refer to the user manual that comes with your motherboard.